

9619-M/B

ADATTATORE MECCANICO PER PROIETTORE SINGOLO
MECHANICAL SINGLE SPOT ADAPTER

Dati tecnici

Technical data



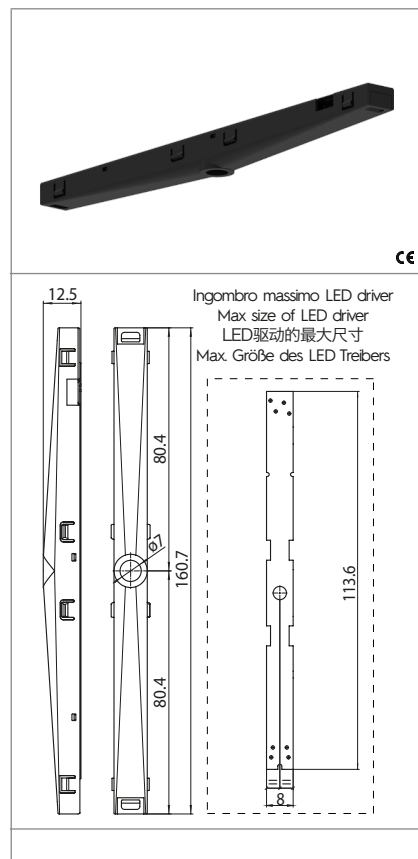









- Corrente e tensione nominale - Rated current and voltage	2A-60Vdc 1A-60Vdc



Caratteristiche



Characteristics

- Corpo in poliammide. Colori disponibili: nero (B) - Polyamide body. Available colours: black (B)
- Max. carico: 10N / Max. momento torcente: 0,5Nm - Max. load: 10N / Max. torque: 0,5Nm
- Con alloggiamento per LED driver. Vedi disegno per dimensioni massime - With housing for LED driver. See technical drawing for max. dimension

 fissaggio ad innesto snap-in fixing	 classe III class III	 S-9619-M/M6	 S-9619/41
 S-9619/42	 S-9619-D/42		
			

Marchi di qualità

Quality marks

 (WORK IN PROGRESS)
 (WORK IN PROGRESS)

Direttive Europee

European directives

Conforme "RoHS"
"RoHS" compliant
Non soggetto alla "RAEE"
Not subject to "WEEE"

Pesi e confezioni

Weights and packaging

Art. Codice prodotti Product references	g Peso netto Net weight	n° pz per sacco per bag	n° pz per scatola per box	n° pz per cartone per carton
9619-M/B				

Note

Notes